

BEFORE USE:

Please read the instructions carefully. You must inspect the appliance including its cable and plug for any signs of damage. If the product is damaged, DO NOT USE and contact your supplier immediately for refund or replacement.

This product is only suitable for well insulated spaces or occasional use.



V 2024-08

**INSTRUCTION
MANUAL FOR MODELS**

GLASS PANEL HEATER
MY284859 / MY284860

| GENERAL INFORMATION

Thank you for choosing the Mylek glass panel heater. Please take time to carefully read and understand the entire instruction manual before using the product and then save it for future reference. We reserve the right for any errors in text or images and any necessary changes made to technical data. If you have any questions concerning operational or technical problems please contact our Customer Services on **0800 091 3171**.

| BEFORE USING THIS HEATER

When using electrical appliances, basic precautions should always be followed to reduce the risk of fire, electric shock, and injury to persons. This includes but is not limited to the following.

CAUTION

This appliance is not intended for use by persons (including children) with reduced physical, sensory or mental capabilities, or lack of experience and knowledge of the product. The appliance is to be operated by responsible adults only after reading and understanding these instructions. Children should be supervised at all times to ensure that they do not play with the appliance. Children under 16 years should not operate the unit or carry out maintenance and/or clean the unit. Any infirmed persons in the vicinity of the unit should be accompanied by a responsible and competent

able bodied adult. Remove the packing and make sure that the appliance is intact. If there is any doubt concerning the integrity of the unit do not use the appliance and contact our recommended after-sales service.

Do not leave any packaging materials within easy reach of children. Before switching on appliance check if the electrical voltage and frequency of the circuit correspond to those indicated on the appliance. Use the appliance only for the stated purpose, namely as a heater for domestic use. Do not use it for any other application as it could be dangerous.

| IMPORTANT SAFETY REQUIREMENTS

- This appliance can be used by children aged from 8 years and above and persons with reduced physical, sensory or mental capabilities or lack of experience and knowledge if they have been given supervision or instruction concerning use of the appliance in a safe way and understand the hazards involved. Children shall not play with the appliance. Cleaning and user maintenance shall not be made by children without supervision.
- Children of less than 3 years should be kept away unless continuously supervised.
- Children aged from 3 years and less than 8 years shall only switch on/off the appliance provided that it has been placed or installed in its intended normal operating position and they have been given supervision or instruction concerning use of the appliance in a safe way and understand the hazards involved. Children aged from 3 years and less than 8 years shall not plug in, regulate

and clean the appliance or perform user maintenance.

- **CAUTION** - Some parts of this product can become very hot and cause burns. Particular attention has to be given where children and vulnerable people are present.
- If the supply cord is damaged, it must be replaced by the manufacturer, its service agent or similarly qualified persons in order to avoid a hazard.
- **CAUTION:** In order to avoid a hazard due to inadvertent resetting of the thermal cutout, this appliance must not be supplied through an external switching device, such as a timer, or connected to a circuit that is regularly switched on and off by the utility.
- The heater must not be located immediately below a socket-outlet.
- Means for disconnection having a contact separation in all poles must be incorporated in the fixed wiring in accordance with the wiring rules.
- For correct installation on the wall, thanks to refer to 'Installation on wall' part.
- Fixed heaters are to be installed so that switches and other controls cannot be touched by a person in the bath or shower.



WARNING: In order to avoid overheating, do

not cover the heater.

- Do not use this heater if it has been dropped.
- Do not use if there are visible signs of damage to the heater.
- Use this heater on a horizontal and stable surface, or

install correctly and securely to a wall, as shown in this user manual.

- **WARNING:** Do not use this heater in small rooms when they are occupied by persons not capable of leaving the room on their own, unless constant supervision is provided.
- **WARNING:** To reduce the risk of fire, keep textiles, curtains, or any other flammable material a minimum distance of 1m from the air outlet.
- **PLEASE NOTE:** Household dust, lit cigarettes, candles and oil burners, combined with the convection effect of electric heaters can cause significant soot deposits to build up on the surface directly above and to the sides of the heater. This is not a fault of the heater. Extensive burning of candles or smoking in the operating environment of this product can produce heavy discolouration within a few months of use.

Notice to Landlords, Universities, Housing Associations, Charitable Associations Or Other Similar Associations:

It is your responsibility to your Tenants where these heaters are fitted to make sure Risk Assessments are carried out for these heaters and your Tenant's are fully trained on how to operate this heater correctly and safely. The Tenant's are also given a copy of these user instructions for guidance and understand the importance of reading them and keeping them safe and at hand at all times. The Tenant's should also understand the safety importance of NEVER covering the heater or heater vents at any time for drying or warming garments, or any types of materials. The Tenant's should also be trained about the correct clearance around the heater

at all times. Not following correct guidance and training could result in the unit overheating system activating, risk of fire, injury or even death.

WARNING: this product should only be installed in Zone 2 and above only if fitted in a bathroom according the national wiring rules.

Note: The drawing below is for reference only.

If this unit is fitted in a bathroom then it should be fitted by a qualified electrician.

In the case as of buildings room, a room receiving a bath or a shower and socket-outlets lower or equal to 32 A the circuit corresponding must be protected by a device with differential residual current (RCD) lower or equal to 30 mA.

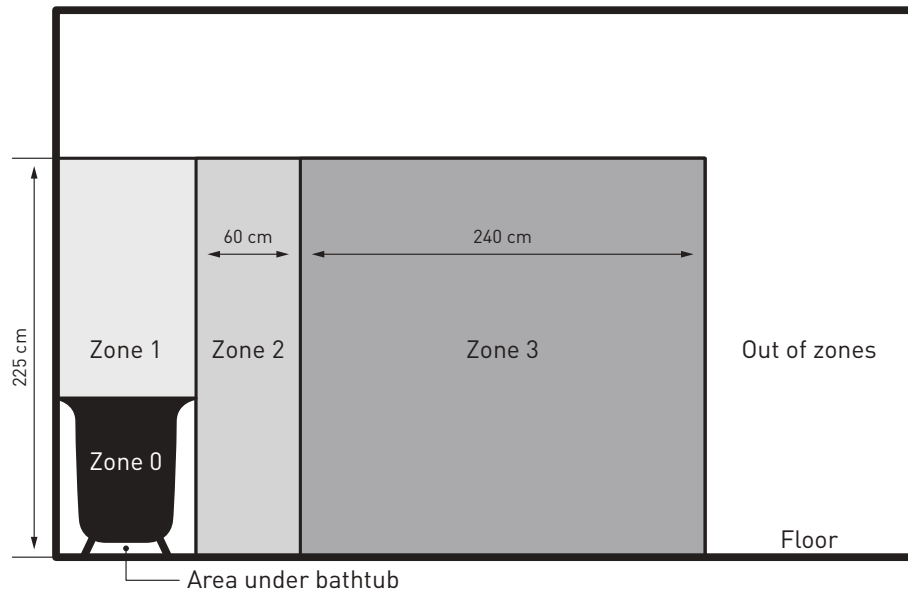

THIS PRODUCT IS FOR ROOM HEATING
FOR HOUSEHOLD USE ONLY

| SPECIFICATIONS

Model No.	RATED VOLTAGE	RATED POWER
MY284859	AC230V, 50-60Hz	2000W
MY284860	AC230V, 50-60Hz	2000W

| STRUCTURE AND PARTS

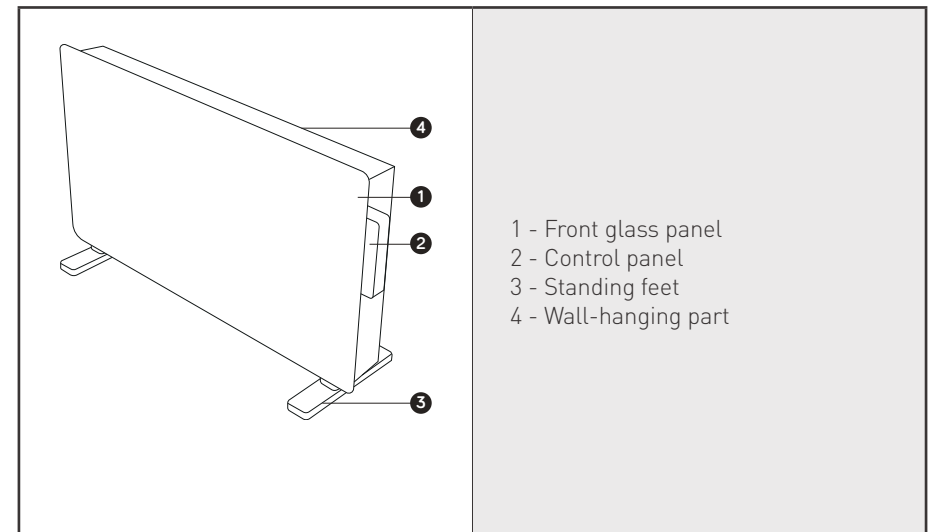

INSTALLATION ON THE WALL

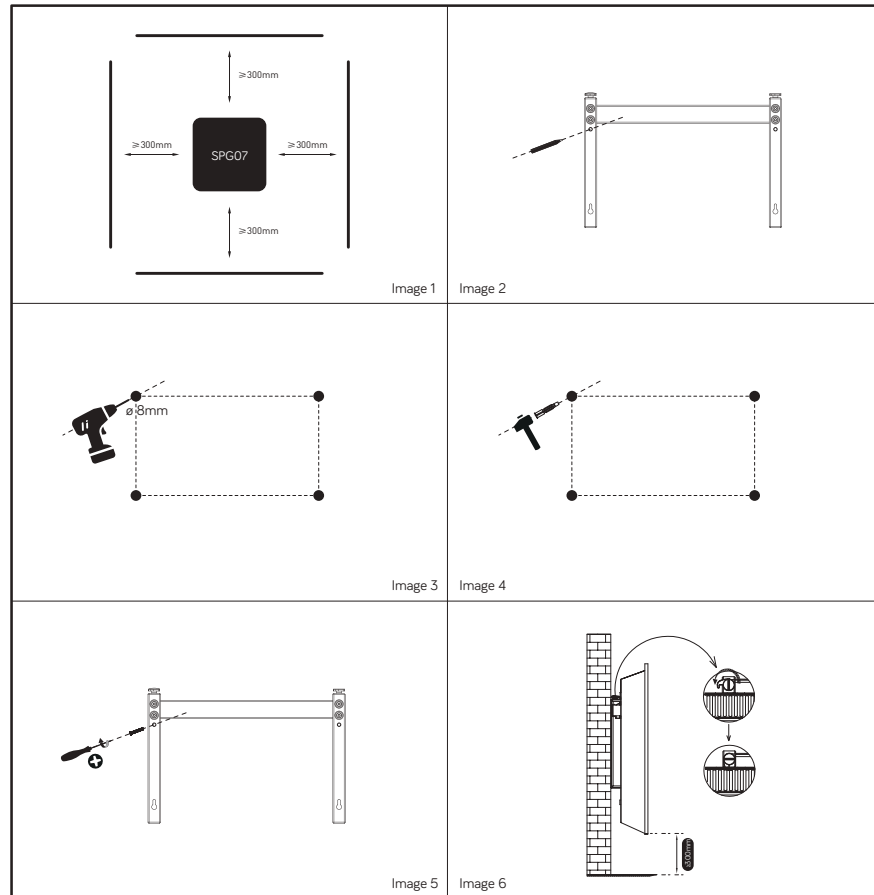

- For wall mounting, carefully remove the already constructed hanging bracket from the rear of the heater by turning the two plastic securing grips located at the top of the bracket. It is good practice to remove the bracket and replace a few times so you are familiar on how it attaches before securing to the wall.
- Using the hanging bracket as a template, place the hanging bracket level against the wall as a guide ruler (please make sure the holes are parallel level), use a marker pen to mark the hole position. Image 2 on Figure 1 above.
- Drill holes on the wall with 08mm drill bit. Image 3 on Figure 1 above.
- Insert the plastic wall plugs. Image 4 on Figure 1 above.
- Securely fasten the hanging bracket to the wall with the screws provided. Make sure the hanging bracket is in the correct direction. Image 5 on Figure 1 above.
- Gently insert the bottom of the heater to the hanging bracket first and then push the

top of the heater body onto the hanging bracket. It is good practice to try attaching the hanging bracket to the heater and taking off, so you are familiar with how it attaches and detaches.

- When the heater is attached to the hanging bracket, secure into place by turning the two plastic securing grips. Image 6 on Figure 1 above.

Warning: Be sure to keep a distance around the heater of at least 30cm (300mm) see image above. Warning! When drilling holes, always check to ensure there is no electrical wiring, gas pipes, water pipes etc in the area to be drilled.

To fix the feet, pls see the picture as below:

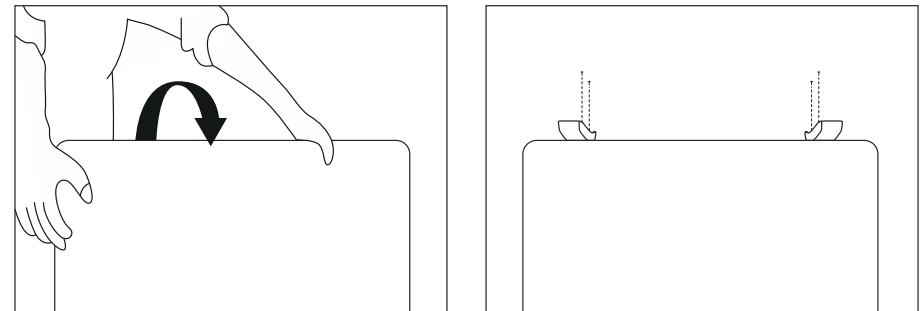

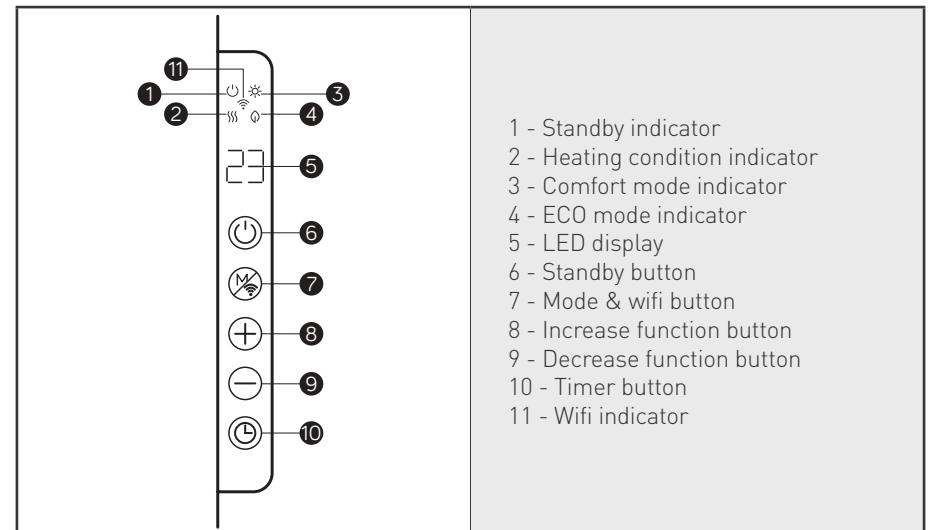

If not use for wall-mounted, pls assembly the feet as above picture.

CONTROL PANEL AND SCREEN





- 1 - Standby indicator
- 2 - Heating condition indicator
- 3 - Comfort mode indicator
- 4 - ECO mode indicator
- 5 - LED display
- 6 - Standby button
- 7 - Mode & wifi button
- 8 - Increase function button
- 9 - Decrease function button
- 10 - Timer button
- 11 - Wifi indicator









| HOW TO USE

- Plug the appliance into a AC 230V 50-60Hz socket and the unit will “beep” once. The indicator light  illuminates for standby mode.
- Press  to turn on the heater. For the first use the heater is in factory default settings as shown below: (If default settings are different, it will simply be because the unit has been quality tested after production).
Heating mode: Comfort mode
Target temperature setting: 22 °C
Day: 1(Monday), Time: 00:00 (Off)
Window open function: Off
Timer: Off
- Press  to turn off the heater and put into standby mode when not in use.
- Unplug the product from the power source when not in use.



| CLOCK SETTING

- Press down  for 3 seconds to enter clock and day of week setting
- The screen will display “□□”, press  and  to select the day from 1-7.

1	Monday	2	Tuesday
3	Wednesday	4	Thursday
5	Friday	6	Saturday
7	Sunday		





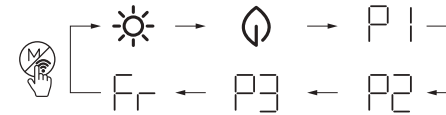

- Press  to confirm day setting and enter the clock hour setting, with the screen display: 
- Press  and  to set the current hour 00-23
- Press  to confirm hour setting and enter the minute setting, with the screen display: 
- Press  and  to set the current minute
- Press  to confirm all settings

| FUNCTIONS SETTING EXPLAINED

Press  to enter mode selection. By pressing , heating mode runs in a continuous cycle as below:



Notice: When the appliance is under heating, the heating condition indicator light  will be illuminated.

-  Comfort mode: Press  and  to set the temperature from 5-35°C.
-  ECO mode: Press  and  to set the temperature from 1-31°C.
- Note: ECO mode=Comfort mode - 4 °C
- Anti-frost mode: the screen display . The target temperature keeps as 7 °C. The temperature can't be adjusted.



P1/P2/P3: Pre-set heating program.

(The image below (Figure 1-5) is just for illustration purposes only and not shown on the LED display.)

Note: If the clock and day setting are not set correctly P1/P2/P3 will not operate to the current time. it is advised to set day and clock setting in advance.

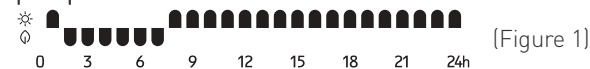
: (Monday-Sunday) Unadjustable program.





00:00am – 01:00am  comfort mode, 01:00am – 07:00am  ECO mode

07:00am – 00:00am  comfort mode.

: (Monday-Friday) Unadjustable program.



00:00am – 01:00am  comfort mode, 01:00am – 05:00am  ECO mode

05:00am – 09:00am  comfort mode, 09:00am – 19:00pm  ECO mode

19:00pm – 00:00am  comfort mode

: (Saturday-Sunday) Unadjustable program.

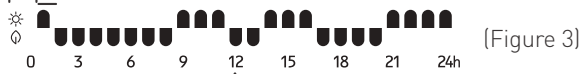

00:00am – 01:00am comfort mode, 01:00am – 08:00am ECO mode
 08:00am – 11:00am comfort mode, 11:00am – 13:00pm ECO mode
 13:00pm – 16:00pm comfort mode, 16:00pm – 20:00pm ECO mode
 20:00pm – 00:00am comfort mode.

: (Monday-Friday) Adjustable program

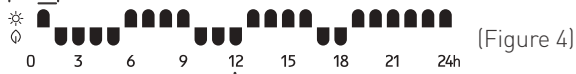

00:00am – 01:00am comfort mode, 01:00am – 05:00am ECO mode
 05:00am – 09:00am comfort mode, 09:00am – 12:00pm ECO mode
 12:00pm – 16:00pm comfort mode, 16:00pm – 18:00pm ECO mode
 18:00pm – 00:00am comfort mode.

: (Saturday-Sunday) Adjustable program

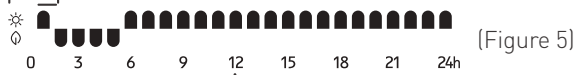

00:00am – 01:00am comfort mode, 01:00am – 05:00am ECO mode
 05:00am – 00:00am comfort mode

P3 adjustable program setting

1. Press until the mode displays, press again for 3 seconds to enter day setting.
2. The screen displays , press and to set from - (Monday-Sunday). Press to confirm and enter hour setting.
3. The screen displays , press and to set from {00-23}. Press to choose heating mode for every hour (Comfort mode , ECO mode or no symbols for anti-frost mode. Please note under the anti-frost mode, the heater will only operate if the temperature drops to 7°C)
4. Repeat the operation until you have completed the schedule of every hour and every day.

Note: After setting heating mode for hour 23, press to come back to day setting.

Note: when screen displays , press finish all setting with display of .

Note: For example, if set Comfort mode when the screen display , it means that it would be in comfort mode during 00:00-00:59.

WEEKLY PROGRAM

Only can be set via TUYA App. The display will show when the weekly program is chosen on App.

I COUNTDOWN TIMER FUNCTION

- Press timer button one time, the screen display “” and keeps flashing. press and to set timer from 0-9 hours. Wait 3 seconds to confirm setting. When the timer-off function is enabled, the display shows the remaining time. Adjust the timer to 0h to close this function.
- Timer quick setting: Press one time, the screen display “”, press one time again to select the timer from 2h,4h,8h,0h in a continuous cycle.
- Notice: The timer off function is not able to be activated in anti-frost (Fr) mode.

I OPEN WINDOW FUNCTION

- Press and button together, the screen displays , then it comes back to display target temp after 3 seconds (if there is timer, display remaining time), which means that the open windows function is ready. When the item is heating, the detected room temp drops rapidly over 2 degrees in 2 minutes, open window function would be activated, while the screen would display and flash. The item stops heating.
- To turn off open windows function completely: Press and button together, the screen displays , then it comes back to display target temp after 3 seconds

I SCREEN CHILD SAFETY LOCK

- To active the child lock, simply press on APP UI and then the control panel will be locked.
- To exit the child lock, press and together to unlock the control panel OR

press  on APP UI.

| PAT TESTING

When used in a workplace, this product must be safety-tested yearly by a qualified electrician (PAT Tested) in order to comply with the Electricity at Work Regulations. We recommend that it is PAT tested regularly when used in a domestic environment.

| MAINTENANCE

1. Always disconnect the appliance and let it completely cool before any maintenance.
2. Use a vacuum cleaner to remove dust on grilles.
3. Clean the outside of the unit with a damp cloth and then dry it with a dry cloth. Never immerse the unit in water, nor let water drip into the unit.

| STORING

1. Always disconnect the appliance, let it completely cool and clean it before storing.
2. If you do not use the device for a long period, put back the unit and the instruction manual to the original carton and store in a dry and ventilated place
3. Do not place any heavy items on top of carton during storing as this may damage the appliance.

| WIFI CONNECTION

Use your phone to scan the QR code below or search for the “**TUYA SMART**” App to download and generate a free account. You can also visit www.tuya.com for more information. Please note Tuya are constantly developing and upgrading their Apps to make them more user friendly and sometimes, displays may differ slightly to the display shown in this manual due to upgrades. If you have any questions concerning technical problems, please contact our Customer Services on **0800 091 3171** quoting the model number found on the unit rating label.



Select your country code, enter your mobile number and select “Get” to receive a message containing your verification code.

Enter your verification code and select “Login”.

When first using the App to turn on the heater, the WiFi indicator light will flash on the unit, to connect the unit to the App.

Reset the WiFi, press the WiFi  button for 3 secs, the WiFi indicator light will flash rapidly, you can now connect your device to the App.

A Quick connection :

Turn on your bluetooth in you mobile phone, then set as following steps.

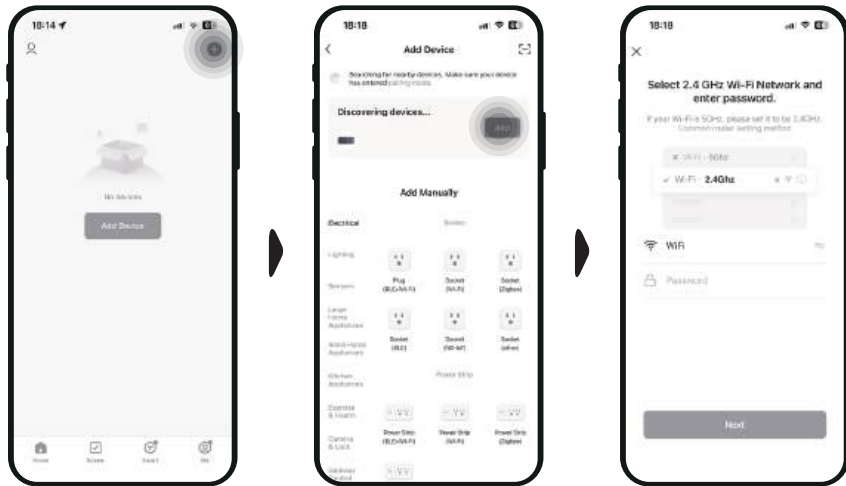

Press "+" in the right-top position and go to next step

Press "Add"

Select 2.4 GHz WiFi Network and enter the password, press next

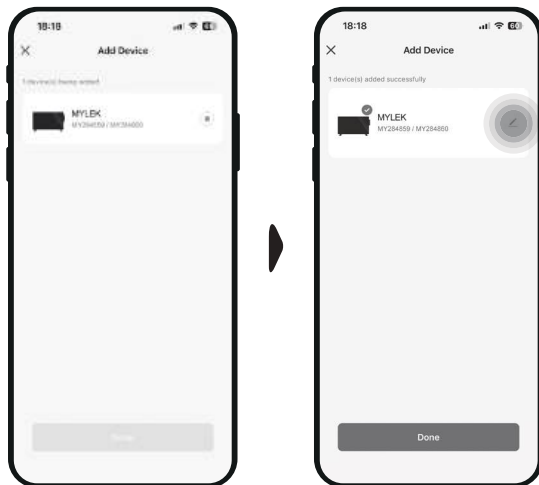

Wait it's connected and press "Next", the APP will show as below

You can press to modify the name of the product

B Normal connection :

If the bluetooth is not on, pls follow the next step.

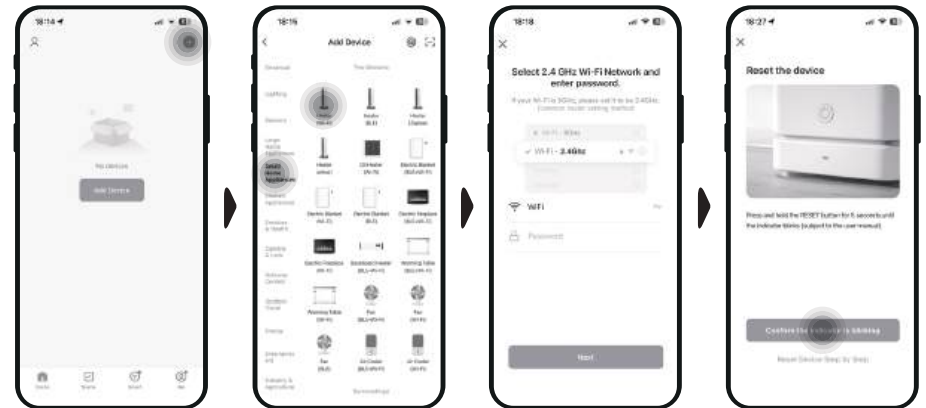

Press "+" in the right-top position and go to next step

Choose small home appliance and heater

Select 2.4 GHz WiFi Network and enter the password, press next

Pls ensure the wifi logo is twinkling, if not, pls long press (ⓧ) for 5 seconds until the WiFi logo start to twinkle

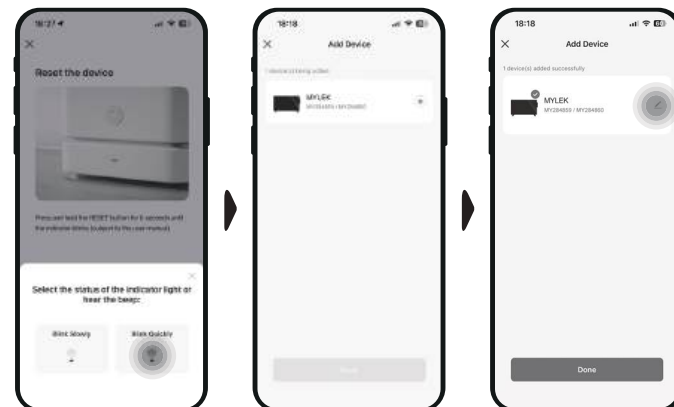

Press "Blink Quickly"

Wait it's connected and press "Done", the APP will show as below

You can press to modify the name of the product

UI interface :

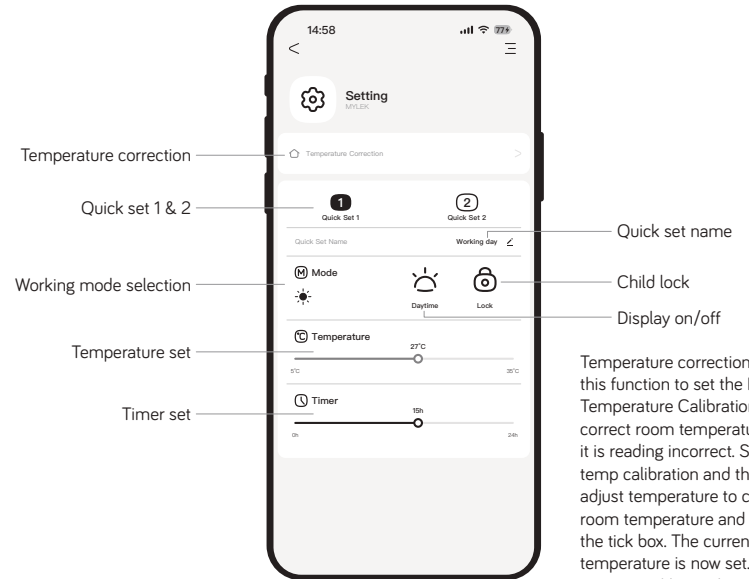

Temperature correction: Use this function to set the Room Temperature Calibration to the correct room temperature if it is reading incorrect. Select temp calibration and then adjust temperature to current room temperature and select the tick box. The current room temperature is now set.

Note: to calibrate the temperature, pls ensure the heater already worked for more than 1 hour.
Customer can preset usual using way in different situation and name it (can keep 2 quick set).

Please note when choosing P1/P2/P3 in the APP, the unit will operate to the settings shown in the manual. If you set P3 manually on the unit and you choose P3 in the APP the unit will operate to the settings you have set. You can also choose to set to your own requirements by selecting the Weekly program P7 within the App.

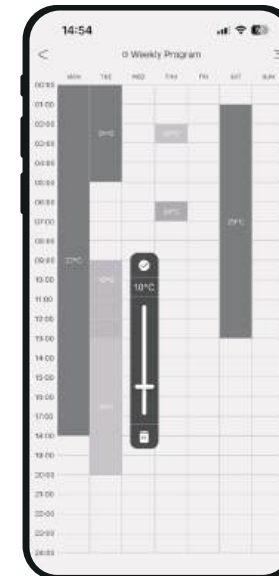
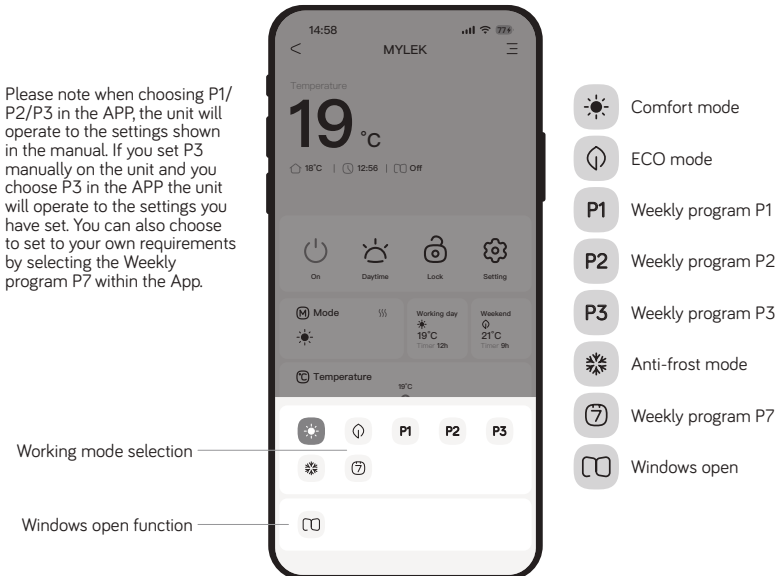

Weekly program (P7) : Set the working time and working temperature for every hour in everyday.

Information requirements for electric local space heaters

Model identifier(s): MY284859 / MY284860																																									
Item	Symbol	Value	Unit																																						
Heat output																																									
Nominal heat output	P _{nom}	2,0	kW																																						
Minimum heat output (indicative)	P _{min}	N/A	kW																																						
Maximum continuous heat output	P _{max,c}	2,1	kW																																						
Auxiliary electricity consumption																																									
At nominal heat output	e _{lmax}	0.000	kW																																						
At minimum heat output	e _{lmin}	0.000	kW																																						
In standby mode	e _{l sb}	0.001	kW																																						
<table border="1"> <tr> <td colspan="2">Type of heat input, for electric storage local space heaters only (select one)</td> </tr> <tr> <td>Manual heat charge control, with integrated thermostat</td> <td>Not applicable</td> </tr> <tr> <td>Manual heat charge control with room and/or outdoor temperature feedback</td> <td>Not applicable</td> </tr> <tr> <td>Electronic heat charge control with room and/or outdoor temperature feedback</td> <td>Not applicable</td> </tr> <tr> <td>Fan assisted heat output</td> <td>Not applicable</td> </tr> <tr> <td colspan="2">Type of heat output/room temperature control (select one)</td> </tr> <tr> <td>Single stage heat output and no room temperature control</td> <td>[no]</td> </tr> <tr> <td>Two or more manual stages, no room temperature control</td> <td>[no]</td> </tr> <tr> <td>With mechanic thermostat room temperature control</td> <td>[no]</td> </tr> <tr> <td>With electronic room temperature control</td> <td>[no]</td> </tr> <tr> <td>Electronic room temperature control plus day timer</td> <td>[no]</td> </tr> <tr> <td>Electronic room temperature control plus week timer</td> <td>[yes]</td> </tr> <tr> <td colspan="2">Other control options (multiple selections possible)</td> </tr> <tr> <td>Room temperature control, with presence detection</td> <td>[no]</td> </tr> <tr> <td>Room temperature control, with open window detection</td> <td>[yes]</td> </tr> <tr> <td>With distance control option (WiFi Option)</td> <td>[yes]</td> </tr> <tr> <td>With adaptive start control</td> <td>[no]</td> </tr> <tr> <td>With working time limitation</td> <td>[yes]</td> </tr> <tr> <td>With black bulb sensor</td> <td>[no]</td> </tr> </table>				Type of heat input, for electric storage local space heaters only (select one)		Manual heat charge control, with integrated thermostat	Not applicable	Manual heat charge control with room and/or outdoor temperature feedback	Not applicable	Electronic heat charge control with room and/or outdoor temperature feedback	Not applicable	Fan assisted heat output	Not applicable	Type of heat output/room temperature control (select one)		Single stage heat output and no room temperature control	[no]	Two or more manual stages, no room temperature control	[no]	With mechanic thermostat room temperature control	[no]	With electronic room temperature control	[no]	Electronic room temperature control plus day timer	[no]	Electronic room temperature control plus week timer	[yes]	Other control options (multiple selections possible)		Room temperature control, with presence detection	[no]	Room temperature control, with open window detection	[yes]	With distance control option (WiFi Option)	[yes]	With adaptive start control	[no]	With working time limitation	[yes]	With black bulb sensor	[no]
Type of heat input, for electric storage local space heaters only (select one)																																									
Manual heat charge control, with integrated thermostat	Not applicable																																								
Manual heat charge control with room and/or outdoor temperature feedback	Not applicable																																								
Electronic heat charge control with room and/or outdoor temperature feedback	Not applicable																																								
Fan assisted heat output	Not applicable																																								
Type of heat output/room temperature control (select one)																																									
Single stage heat output and no room temperature control	[no]																																								
Two or more manual stages, no room temperature control	[no]																																								
With mechanic thermostat room temperature control	[no]																																								
With electronic room temperature control	[no]																																								
Electronic room temperature control plus day timer	[no]																																								
Electronic room temperature control plus week timer	[yes]																																								
Other control options (multiple selections possible)																																									
Room temperature control, with presence detection	[no]																																								
Room temperature control, with open window detection	[yes]																																								
With distance control option (WiFi Option)	[yes]																																								
With adaptive start control	[no]																																								
With working time limitation	[yes]																																								
With black bulb sensor	[no]																																								
Contact details	Hygiene Supplies Direct Limited, Ground floor, Tayson House, Methley Road, Castleford WF10 1PA																																								



This marking indicates that this product should not be disposed with other household wastes throughout the EU. To prevent possible harm to the environment or human health from uncontrolled waste disposal, recycle it responsibly to promote the sustainable reuse of material resources. To return your used device, please use the return and collection systems or contact the retailer where the product was purchased. They can take this product for environmental safe recycling.

The importer retains his right to make changes in appearance and completeness of the item without preliminary notification to the customer.

The item is for indoor use only.

The manufacturer does not assume any liability for any damage caused directly or indirectly by not following this instruction manual, general safety rules, or interference in the construction of the product.

| SERVICE WARRANTY

Hygiene Supplies Direct guarantees the product free from defects in materials and workmanship for a period of 1 year from date of purchase. Should this unit be operated under conditions other than those recommended, at voltages other than the voltage indicated on the unit, or any attempts made to service or modify the unit, then the warranty will be rendered void. The product you buy may sometimes differ slightly from illustrations. This warranty is in addition to, and does not affect, your statutory rights. If you have any problems with this product, please call our Help Desk on **0800 091 3171** or email: sales@hygienesuppliesdirect.com

MYLEK[®]

Hygiene Supplies Direct Limited, Ground Floor, Tayson House,
Methley Road Castleford, West Yorkshire, WF10 1PA
declares that the Mylek Heaters are exclusively manufactured
and imported for Hygiene Supplies Direct Ltd.